

# Rethink your liquid-liquid separations

## A fresh look investigates general principles in designing process coalescers

R. CUSACK, Koch-Glitsch, LP, Wichita, Kansas

Efficient liquid-liquid separations are an integral part of many industrial processes. Water entrained in oil and other hydrocarbon products can impede quality specifications. Entrained oil in process water streams puts additional demands on effluent treatment systems.

Under the present economic environment, processing production demands push plants and existing equipment beyond the original design capacity. Equipment that formerly made clean-phase separations can no longer do so. And for new plants, strong economic incentives push process designers to incorporate equipment with smaller footprints to minimize weight, plot space and capital costs.

Several examples highlight typical issues encountered with liquid-liquid separation operations and equipment applied in the hydrocarbon processing industry (HPI). Some general principles on design for liquid-liquid (and some vapor-liquid-liquid) separators will also be discussed

Plant operators have found that efficient liquid-liquid separations are critical to achieve optimum plant performance. But, how does one achieve this goal? What are the critical process parameters to be analyzed? What plant data need to be collected? What equipment options are available? How do you choose between these options? To begin the process of answering these questions, we must ask the fundamental question:

### HOW WAS THE LIQUID-LIQUID DISPERSION FORMED IN THE FIRST PLACE?

Understanding how a droplet dispersion formed provides us with an idea of the size droplets present in the dispersion AND their relative volume. This information is crucial when creating effective designs for liquid-liquid separation processes. The three primary mechanisms for droplet creation are mechanical energy input, phase condensation or cooling and chemical reaction.

**Mechanical energy input.** The type of droplet distribution produced by mechanical means is very dependent on the intensity and uniformity of shear forces present at the point of formation. For example, a rotating impeller has the characteristics of high shear at the tips of the impeller and low shear at the center of the impeller. **Result:** It creates a wide range of droplet sizes while mixing the fluids. By contrast, if the fluid mixing occurs in an inline static mixer, the shear characteristics are uniform and produce a very well-defined, narrow droplet distribution. However, if these same liquids unintentionally mix via a centrifugal pump, the shear characteristics are typically very high and very non-uniform. The result is a very wide droplet distribution with a high percentage of very small droplets (often referred to as “fines”) that are much more difficult to separate.

**Phase condensation or phase cooling.** During phase condensation, droplets form on heat exchanger tubes (such as an overhead condenser on a distillation column) and then flow into piping and onto a separator drum. The droplet size distribution is large and easy to separate. By contrast, during bulk-phase cooling (such as in a product storage tank), water comes out of a solution and creates a dispersion that consists of much smaller droplets similar to a “fog.” Separating these droplets can be extremely difficult.

**Chemical reaction.** Similar to the situation of bulk-phase cooling, chemical reaction creates a dispersion that has a very small droplet size distribution that is difficult to separate.

**Separation curves.** Fig. 1 shows the range of droplet sizes associated with each of the listed mechanisms. This chart (Fig. 1) only illustrates typical ranges; it does not tell us the relative volume of the different size drops present in the dispersion.

An *inlet volumetric frequency distribution curve* (Fig. 2) presents the second piece of information needed for effective design. It shows the volume fraction of droplets in a dispersion as a function of droplet diameter. Three values of interest that provide the characteristics of the curve include:

- Maximum droplet size,  $d_{max}$
- Sauter mean droplet size,  $d_{32}$
- Mass mean droplet size,  $d_{50}$ .

These three values determine the shape of the distribution curve, which defines the degree of separation efficiency required to meet a particular outlet specification. The shape and limits of the inlet distribution curve are influenced not only by the mechanism of droplet formation, but also by the physical properties of the liquids and the characteristics of the system piping.

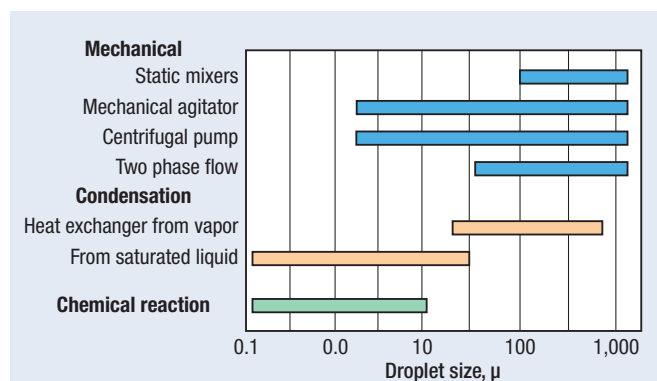

FIG. 1 Typical droplet size ranges for various mechanisms (microns).

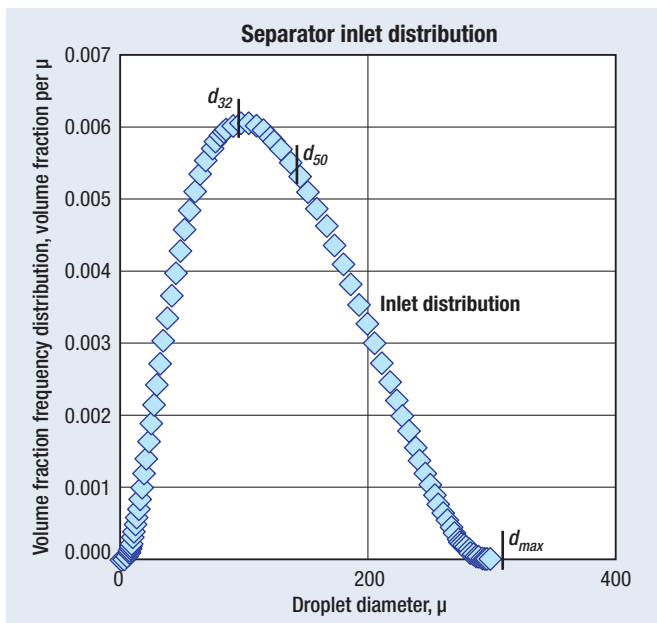

FIG. 2 Inlet droplet volumetric frequency distribution curve.

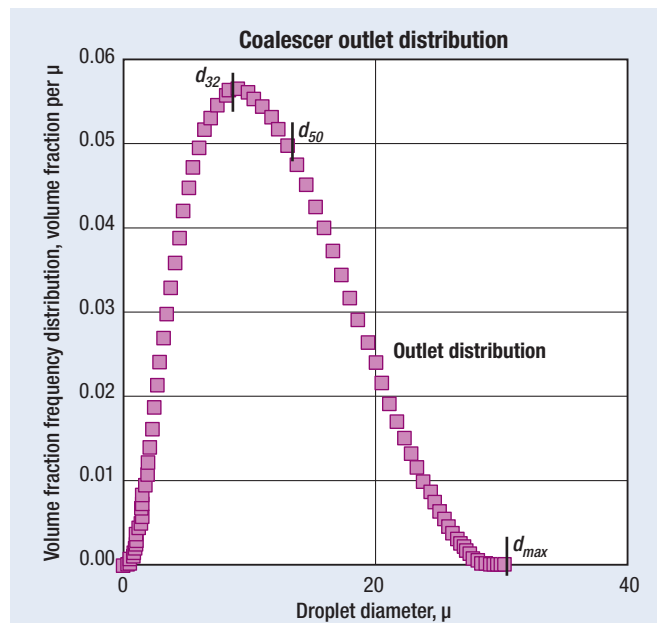

FIG. 4 Outlet droplet distribution curve.

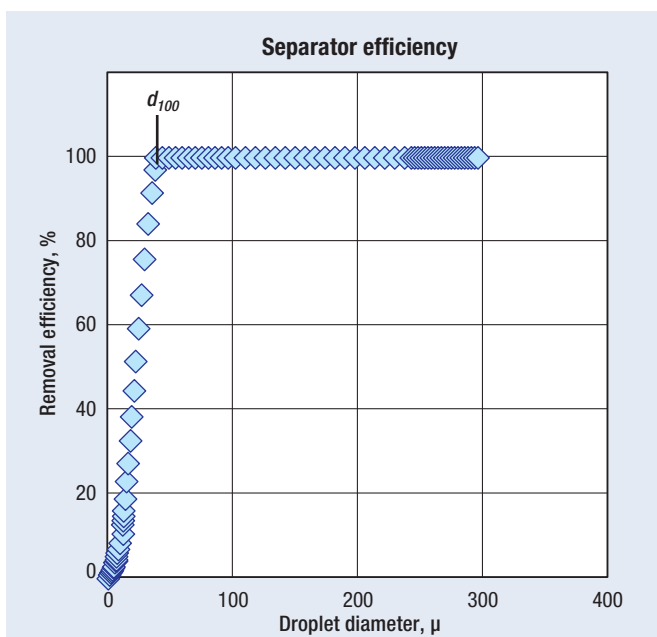

FIG. 3 Coalescer separation efficiency curve.

For example, if a large volume percentage of dispersed phase is present in a long run of piping between the points of mixing and of separation, a significant amount of coalescence can take place within the piping itself. Thus, the separation is easier. In this instance, the distribution curve shifts to the right. In contrast, if gas is present with the liquid in the pipeline and creates high velocity, the liquids will continue to mix as they flow through the pipe. This causes a more difficult separation, which shifts the distribution curve to the left.

The next piece of information necessary to analyze is from the *efficiency curve of the separator* (Fig. 3). This graph shows the removal efficiency as a function of droplet size. Of particular interest, the *cutpoint droplet size*,  $d_{100}$ , represents the smallest droplet

that is removed at 100% efficiency. All droplets above this value are completely removed, and droplets below this value are removed with varying degrees of efficiency based on droplet diameter. Changing the design of the vessel and/or internals can modify the shape of the separation efficiency curve, i.e., shift the curve to the left or to the right as needed, to match separation requirements.

When the design meets the required process efficiency, then the *outlet droplet distribution curve* (Fig. 4) is the final curve generated. This curve represents the volumetric distribution of droplets remaining in the outlet stream when the coalescing and settling processes are complete. Armed with the physical properties of the liquids, the amount and size distribution of dispersion present and characteristics of the system piping and components, the next step is to create a design to separate liquids.

### SEPARATING LIQUID-LIQUID DISPERSIONS

The primary methods for separating liquid-liquid dispersions are:

- Gravity settling
- Enhanced-gravity settling
- Coalescing
- Centrifugal force
- Electrical charge.

Separation designs frequently use the first three methods due to design simplicity, a wide range of applicability, and robust design. The last two (centrifugal force and electrical charge) are specialized techniques that apply to limited applications, and several of those applications are switching to one of the other methods for the reasons noted above. We will focus only on the first three—gravity settling, enhanced gravity settling and coalescing.

**Gravity settling.** The simplest of all liquid-liquid separators is the gravity settler (Fig. 5). The gravity settler works solely on the principle of Stokes Law, which predicts the rate of rise or fall of droplets of one fluid inside another in accordance with Eq. 1. The two most important physical properties in the settling process are illustrated by Eq. 1:

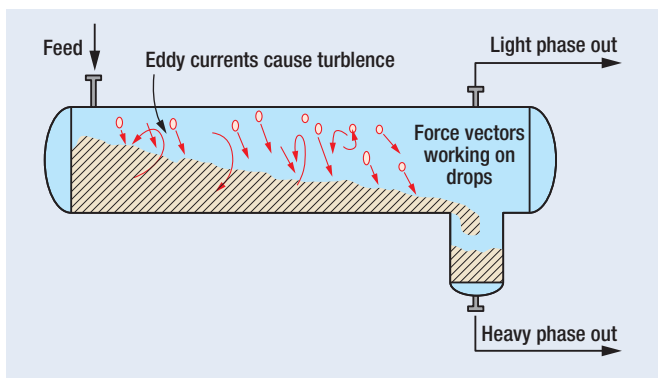

FIG. 5 Typical arrangement of a gravity settler.

**Stokes' Law**

$$V_s = \frac{g(\rho_H - \rho_L)d^2}{18\mu} \quad (1)$$

where:

- $V_s$  = Settling velocity, cm/s
- $g$  = Gravitational constant, 980 cm/s<sup>2</sup>
- $\rho_H$  = Density of heavy liquids, g/cm<sup>3</sup>
- $\rho_L$  = Density of light liquid, g/cm<sup>3</sup>
- $d$  = Droplet diameter, cm
- $\mu$  = Continuous phase viscosity, poise = g/cm-s

The key parameters are:

- Density difference between the phases
- Viscosity of the continuous phase.

Increased density difference makes the separation easier; increased viscosity of the continuous phase makes it more difficult. On the surface, the equation looks simple, straightforward, and easy to apply. However, this simplicity is deceiving because its formulation is based on some fundamental assumptions that limit its applicability.

The Stokes' Law settling equation assumes 1) the drops are truly spherical and 2) they are moving freely in stagnant liquid. Either of these assumptions is rarely the case (except possibly for the situation where the fluids are in a stagnant storage tank and subject only to gravity forces).

In more typical cases, the fluids flow horizontally in a vessel at Reynolds numbers well into the turbulent regime. This turbulence can deform the droplets from a spherical shape to an irregular shape that increases drag forces and hinders the settling rate. The turbulence can also create eddy currents that carry droplets along with them in the wrong direction. As a result, when sizing equipment using Eq. 1, it is necessary to apply "correction factors" that will account for the turbulence effects. Determining these correction factors is very difficult to do even with today's powerful computational fluid dynamics software. For all the listed reasons, enhanced-gravity settling becomes the recommended settler type.

**Enhanced gravity settling.** As shown in Fig. 6, enhanced-gravity settling minimizes the turbulence effects by dividing the stream into a number of separate channels. Dividing the flow into separate channels provides four primary benefits:

- Decreases the effective diameter, thereby greatly reducing the

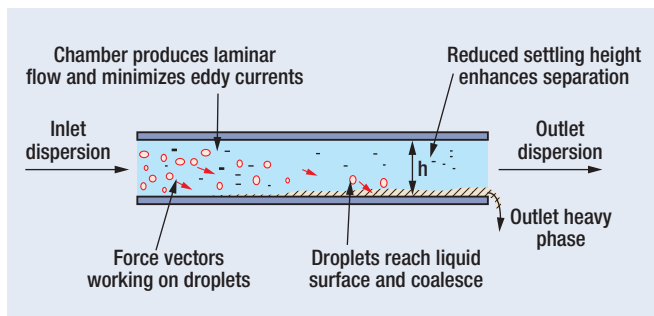

FIG. 6 Separation action with enhanced-gravity settling.

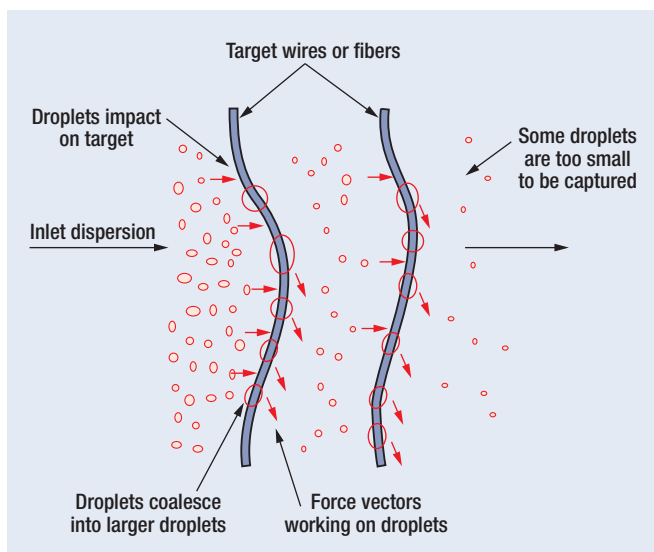

FIG. 7 Coalescing process using surface energy forces with media.

Reynolds number of the flowing fluid and producing a deep laminar flow environment that enhances the gravity settling rate.

- Isolates the fluid in separate channels, thereby putting limits on how far droplets can "wander" and reducing the negative impact of eddy currents.
- Decreases the distance a droplet needs to rise or fall before reaching an interface, thereby greatly lowering the settling time requirement.
- Provides multiple interfaces inside the equipment where droplets can coalesce, thereby greatly increasing the coalescence process.

These benefits promote enhanced gravity settling and it is the recommended design rather than an empty settler vessel working on gravity alone. However, despite these improvements, there are situations where the droplets are so small, the density difference is so low or the continuous phase viscosity is so high that gravity forces alone cannot make an effective separation. In these cases, designs often add a coalescing step.

**Coalescing.** When gravity forces alone do not produce an efficient separation, adding a coalescing step (Fig. 7) to the process can improve separation efficiency. Coalescing designs insert targets into the flow path of the fluids. The droplets impact the targets and collect on the surfaces of the targets through surface energy forces. Once captured, these individual droplets combine (i.e., coalesce) to form larger droplets that are much easier to settle downstream.

■ It has long been said that “oil and water do not mix.” But, actually they do. And when water and oil do mix, it usually results in major problems. For example, consider a car engine. A little bit of oil or a little bit of water in the wrong place can result in tremendous damages to the engine.

The efficiency of any particular coalescing medium can be related to the dimensionless Stokes number ( $St$ ) shown in Eq. 2. Target collection efficiency increases as the value of the Stokes number increases, i.e., the higher the value of the Stokes number, the greater the target collection efficiency.

#### Stokes number

$$St = \frac{\rho_D v (d_p)^2}{18 \mu d_t} \quad (2)$$

Where:

- $St$  = Stokes number (–)
- $\rho_D$  = Dispersed phase density,  $g/cm^3$
- $v$  = Superficial velocity,  $cm/s$
- $d_p$  = Particle diameter,  $cm$
- $\mu$  = Viscosity of continuous phase,  $poise - g/cm-s$
- $d_t$  = Target diameter,  $cm$ .

Based on Eq. 2, separator designs can increase target efficiency by increasing the velocity of the droplets, decreasing the continuous phase viscosity and reducing the target diameter.

**Increasing the velocity** increases the momentum of the droplets and causes more of the smaller diameter drops to impact the targets rather than flowing around them in streamlines. However, higher velocity at the same time increases the drag forces on the coalesced droplets. These forces can prematurely pull the droplets off the coalescing media; thus inhibiting the settling downstream within the settling zone. Consequently, there is an upper limit to this velocity. The goal is to find a balance between a velocity that optimizes impact on the targets and does not interfere with the settling of droplets in the downstream settling zone.

**Decreasing the continuous phase viscosity** reduces the drag forces as the droplets either rise or fall inside the continuous phase. The lower drag forces allow the droplets to rise or fall at higher settling velocities, thus reducing settling time. The principle way to reduce the continuous phase viscosity is to increase the operating temperature. But there is a limit, because increasing the temperature also increases the mutual solubility of the phases, which inhibits separation. Again, designers must find a balance between the competing elements.

**Decreasing the target diameter** reduces turbulence around the targets and allows more smaller droplets to be carried into the targets by the flowing stream. In addition to size, the material of construction of the targets also plays a role. Materials that are preferentially “wet” by the dispersed phase make the best targets. For example, to coalesce water out of oil, hydrophilic (i.e., water-loving) materials, such as stainless steel or fiberglass, are often used. To coalesce oil out of water, oleophilic (i.e., oil-

loving) materials, such as fluoropolymers or polypropylene, are often used. And frequently, coalescing elements are made from a combination of both hydrophilic and oleophilic materials. The combination of materials actually enhances the overall coalescing efficiency above that of using either material alone. The reason that efficiency improves is not fully understood.

Once the target efficiency is optimized, selecting the depth of the coalescing element, as well as the number of targets per unit depth (i.e., the target density), will improve the overall coalescer efficiency.

Because of the complex nature for the coalescing process, it is impossible to effectively design separators from first principles alone. Instead, the design must be practical based upon information gathered from either pilot-plant tests or similar application experience.

### TYPES OF LIQUID-LIQUID SEPARATORS

Five basic separator types are applied in the listed liquid-liquid coalescing and settling internals:

- Two-phase horizontal settler
- Two-phase horizontal coalescer/settler
- Three-phase horizontal coalescer/settler
- Three-phase vertical separator
- Two-phase vertical coalescer.

Which design is chosen depends both on the nature of the feed, as well as on the degree of separation required.

**Two-phase horizontal settler (liquid-liquid).** A two-phase horizontal settler (Fig. 8) typically has a large percentage (5%–10% or greater) of the dispersed phase present in its feed. The most common location is downstream of the mixing or washing steps in a process such as caustic or water washing. Because of the large quantity of dispersed phase in the feed mixture, droplets can easily find each other and coalesce. The droplet size distribution

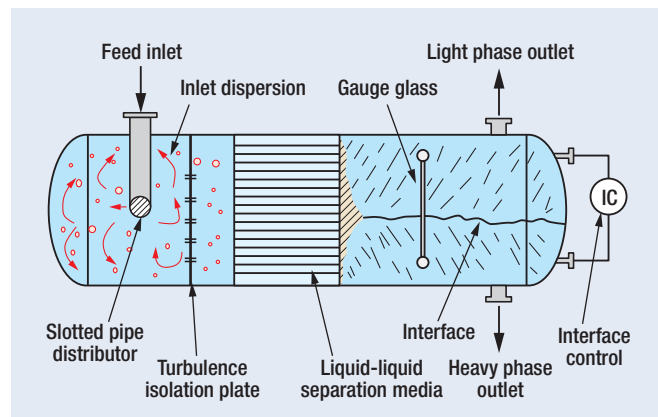

FIG. 8 Typical arrangement for a two-phase horizontal settler.

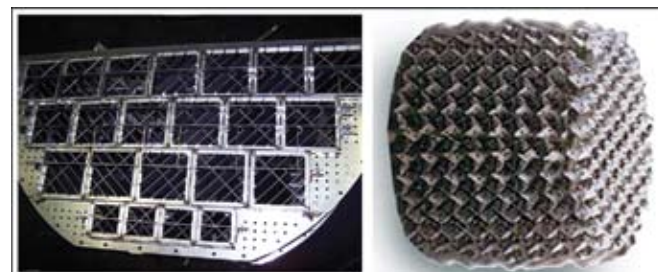

FIG. 9 Plate-pack or corrugated-plate separation media, which are used for higher separation efficiency.

tends to be large, with a Sauter mean droplet size in the range of 500  $\mu$ –1,000  $\mu$ . Unless the density difference is very narrow between the phases and/or the continuous phase viscosity is relatively high (i.e., greater than 5 cP–10 cP), the separation is usually not too difficult.

In these drums, the settling media typically is either plate or corrugated plate separator media internals (Fig. 9). These internals work on the principle of enhanced gravity settling. Plate-pack internals are the best choice when there is concern about fouling or plugging of the media from solids or other materials in the feed. If the feed stream is clean, then a corrugated-plate media is the better choice; it provides higher separation efficiency per unit of length at a lower cost.

For a new installation, a slotted-pipe distributor introduces the feed to the drum and directs the inlet mixture at low velocity toward the upstream head of the vessel. This prevents turbulence effects at the inlet from affecting the rest of the drum. Installing a turbulence isolation plate between the inlet and the first elements of media is a recommended practice. The plate stops any turbulence created at the inlet before it can be transferred downstream where it could affect separation efficiency by sending “waves” down the drum.

While passing through the media, the droplet dispersion grows and settles. By the time it exits the media, it has coalesced into rivulets or streams. After exiting the media, these streams quickly rise and/or fall to the primary interface in the vessel.

The settling section of the drum is downstream of the media. In this section, the final settling takes place and control of the primary interface inside the drum occurs. Depending on process requirements, changing the position of the interface can optimize the settling zone performance. Raising the drum interface increases the residence time of the heavy phase. Conversely, lowering the drum interface increases the residence time of the light phase. However, at the same time, these changes also impact the distance the droplets must rise or fall before reaching the interface and coalescing. The position of the interface for optimum performance must strike a balance between these two different effects. Determining the optimum position is found through trial-and-error experimentation.

### Two-phase horizontal coalescer/settler (liq.–liq.).

The feed stream for a two-phase horizontal coalescer/settler (Fig.

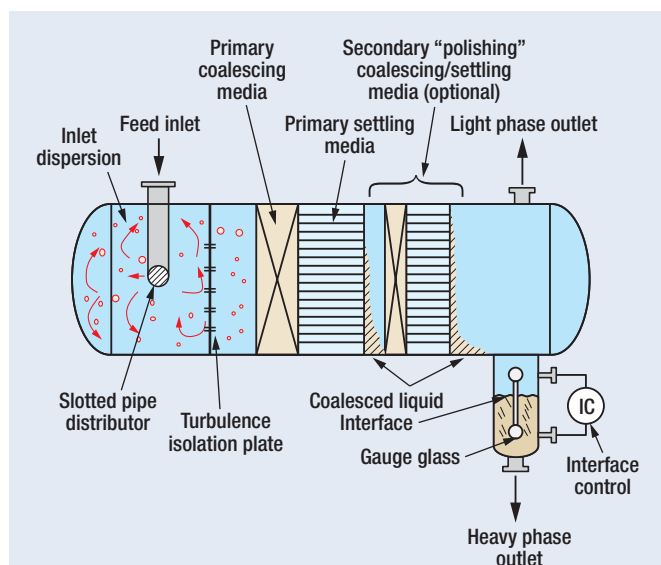

**FIG. 10** Typical arrangement of a two-phase horizontal coalescer/settler.

**Separating the impossible—oil and water.** Entrained oil is found in several processing streams in the HPI. Here are some major areas that must handle entrained liquids:

**Refinery fractionator overhead reflux drums** frequently become a bottleneck when the towers they service are fitted with higher capacity internals. The higher throughput rates in the modified tower increase phase separation demands on the overhead drum. Poor liquid-liquid separation in the drum creates high water levels in the reflux stream that can lead to corrosion on the trays and increased energy consumption in the tower.

**Caustic and amine treaters** are critical components in the light-ends section of any refinery. If the plant increases capacity, the treaters often experience increased solvent losses from the top of the treating tower. Any hydrocarbon entrained with the solvent from the bottom of the treating tower can cause foaming in the downstream stripping tower and this results in production losses.

**Alkylation units** in refineries have several steps where sulfuric acid, caustic or water mix with hydrocarbon streams and then are separated. It is critical that these separations are as sharp and clean as practical to minimize acid and caustic consumption as well as to minimize the potential for fouling/corrosion in downstream equipment.

**Wastewater treatment facilities** are an integral part of any HPI facility. Upsets in the main production plant can often burden the water effluent treatment facilities with increased hydrocarbon removal requirements before water discharge.

10) usually contains a much smaller percentage (less than 5%) of the dispersed phase. This is typically the case for streams coming from an upstream primary separator, condensers or coolers in the process, or streams going to/coming from storage facilities. The droplet sizes are smaller than those for the previous case, usually having a Sauter mean droplet size in the range of 100  $\mu$ –300  $\mu$ .

Because of the lower volume of droplets present, they are less likely to find each other by random motion and to coalesce. Therefore, separator designs for this case require a combination of both coalescing and settling media. As the flow passes through the first stage of media, the wires and/or fibers act as targets where the droplets collect and coalesce. As discussed earlier, adjusting the wire and/or fiber diameter, density, depth and material of

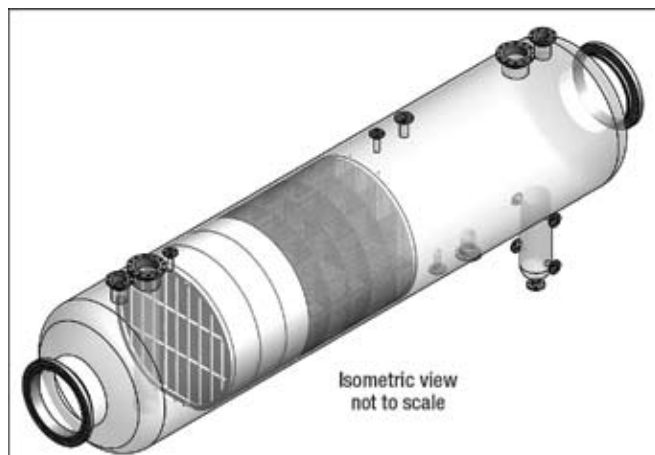

**FIG. 10A** Isometric view of two-phase horizontal coalescer/settler.

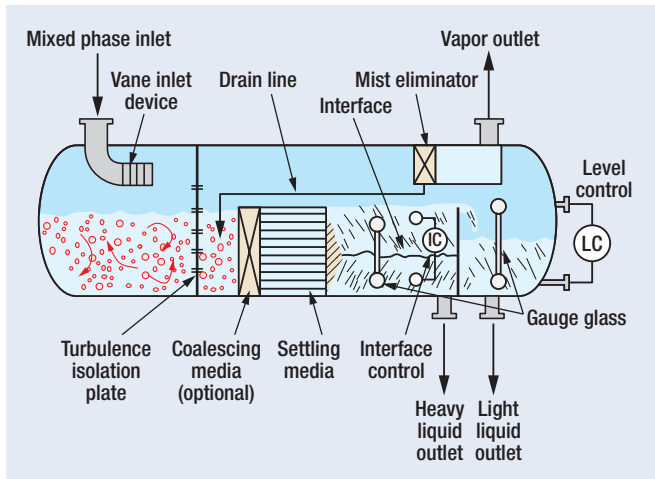

**FIG. 11** Typical arrangement of a three-phase horizontal coalescer/settler.

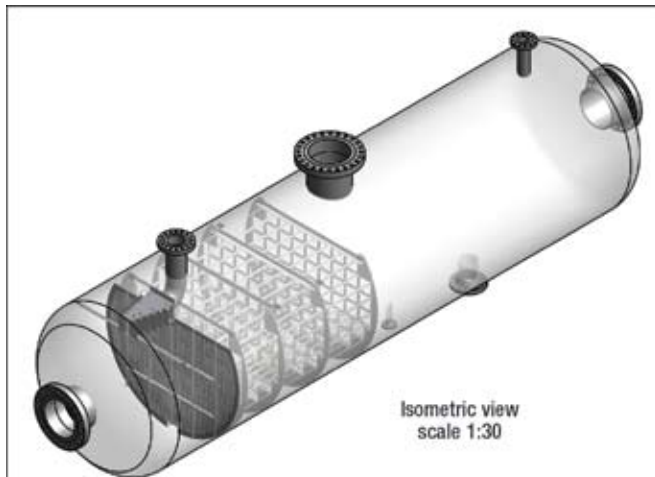

**FIG. 11A** Isometric view of a three-phase horizontal coalescer/settler.

construction controls the efficiency of the selected media.

Once the flow leaves the first-stage coalescing media, it typically enters a settling zone media where the coalesced droplets settle and form rivulets, similar to the process described for the two-phase settlers. The settling sections normally use corrugated-plate separators type media. For applications requiring very stringent outlet stream specifications (usually in the ppm range), installing a final stage of high-efficiency “polishing” media (and sometimes additional settling media) can effectively remove the last traces of very fine droplets. If there is a second “polishing” zone, then the process repeats with a first-stage coalescing media and then a settling media zone. Because the droplets are much smaller, the second zone uses a higher efficiency media.

As shown in Figs. 10 and 10a, similar to the situation with the two-phase settler, a slotted pipe distributor introduces the feed, and a turbulence isolation plate sits just upstream of the first coalescing media. The drum often uses a “boot” (or “hat”) to collect the small volume of dispersed phase and to serve as the liquid-liquid interface controller.

**Three-phase horizontal coalescer/settler.** In the HPI, the three-phase horizontal coalescer/settler (Figs. 11 and 11a) is a common separator type applied in the overhead systems

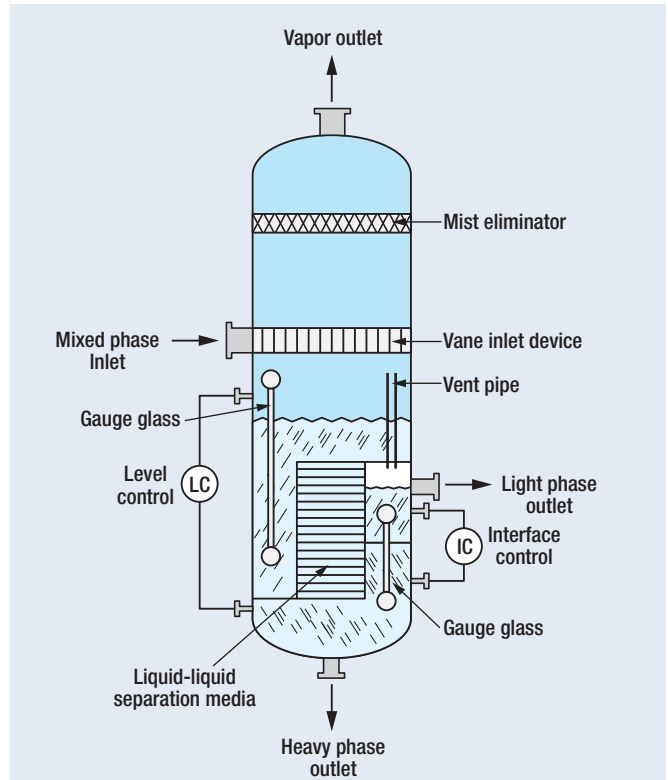

**FIG. 12** Three-phase vertical separator.

of distillation columns or as an upstream separator associated with oil and gas production. As the name implies, this vessel separates three phases: gas, light-phase liquid and heavy-phase liquid (usually water).

The volume of the dispersed phase present in the feed can widely vary. Droplet size distribution can also have a wide range because the feed-line flow is three phase and is flowing at a higher velocity due to the presence of the gas. High velocity causes turbulence in the inlet line that can create very small droplets, particularly if the vapor-liquid surface tension and the liquid-liquid interfacial tension are low. Therefore, proper design of the feed inlet device, gas-liquid separation media and liquid-liquid separation media are all critical. For the feed inlet, designs often use a vane inlet device that gradually reduces the momentum of the incoming stream to minimize turbulence and droplet formation. Such devices can also act as the first-stage gas-liquid separation.

When space or mechanical issues prevent installing an inlet device, the next alternative is to direct the mixed flow toward the upstream head of the vessel. Because the entrance of the feed stream creates a large degree of turbulence, installing single- or double-turbulence isolation plates between the inlet and separation sides of the drum should reduce the effects of inlet turbulence on the downstream gas-liquid and liquid-liquid media. On some high-pressure applications, particularly those related to upstream oil and gas processing (may contain some solids), designs sometimes use a cyclone-type separator as the inlet device.

For the gas-liquid separation in the top of the vessel, a vane-type mist eliminator is usually the best solution. The vane mist eliminator is installed vertically in a housing within the vapor segment of the drum with a drain that extends down into the liquid for

sealing purposes. In revamp situations where it is not possible to install the housing, the vane itself extends down into the liquid for sealing. In clean services, installing a section of wire mesh preceding the vane provides an “agglomerator” stage that grows the droplets for easier removal by the vane, thus maximizing separation efficiency.

For the liquid-liquid separation in the bottom of the drum, the first stage is typically some type of enhanced-gravity separation media such as the plate-pack and corrugated-plate separators described earlier. If fouling is a concern, then the plate-pack media is the best choice. If the system is clean, then corrugated-plate separators media is the standard for the reasons given earlier.

Solids in the feed can present a very high potential for fouling, which is often the case with separators in upstream oil and gas production. In these cases, a segment on the bottom of the media is left open so that the solids can either pass through with the heavy phase or accumulate and be removed via flushing/drain nozzles. If very high separation is required, adding a second “polishing” stage provides the ability to remove the last remnants of entrainment. Again, leaving a bottom segment open reduces plugging concerns.

Downstream of the media in the settling end of the drum, an overflow baffle typically sets the liquid level of the light phase in the body of the vessel. A separate level control instrument regulates the light-phase liquid level on the downstream side of the baffle. If a large amount of dispersed phase is in the feed, then control of the interface is in the main body of the vessel on the upstream side of the overflow baffle (Fig. 11). If the amount of dispersed phase is small, then typically adding a “boot” to the vessel provides the means to collect the coalesced material and control the liquid-liquid interface level.

**Three-phase vertical separator.** Most vertical separators usually handle only two phases—liquid and gas. However, if the liquid being separated forms two phases, incorporating a liquid-liquid separation section in the bottom of the vessel is a common practice. Common applications for these separators include pressure-letdown drums in refinery hydroprocessing units and the bottom of quench towers in ethylene plants. Figs. 12 and 12a show a typical arrangement for the three-phase vertical separator.

As was the case for the three-phase horizontal settler, introducing the feed to the vessel is extremely important because impingement at high velocity on flat surfaces can create fine droplets that are difficult to separate. Also, high vapor velocity across the liquid surface can re-entrain liquid up from the bottom of the drum.

Using a vane-inlet device will gradually reduce the inlet momentum and evenly distribute the gas phase across the vessel diameter. In the gas-liquid portion of the vessel, a wire-mesh mist eliminator provides high separation efficiency. In fouling

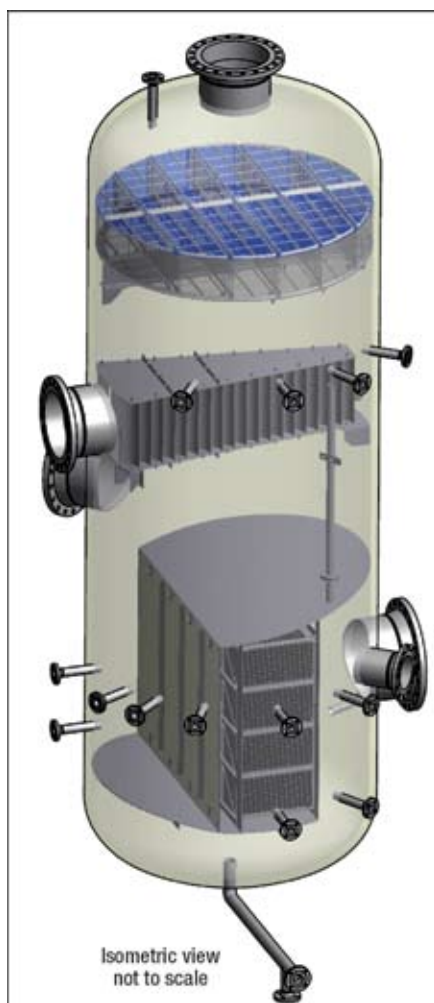

**FIG. 12A** Isometric view of three phase vertical separator.

and/or high liquid load situations where a wire-mesh mist eliminator cannot be used, designs often use a vane-type mist eliminator. Sometimes a combination of vane and mesh is an option when the exiting gas stream requires very small amounts of entrainment.

In the liquid-liquid separation section in the bottom of the drum, either plate-pack internals (when there is a concern about solids or fouling), or corrugated-plate separators type internals provide efficient separation of the two liquid phases.

A level-control instrument maintains the gas-liquid interface in the main portion of the vessel. An interface control instrument located on the downstream side of the separation media maintains the liquid-liquid interface in the bottom of the vessel. The heavy-liquid phase is withdrawn from the bottom of the vessel under the interface control. The light-liquid phase leaves the drum via an overflow nozzle. A vent line allows any entrained gas to rise to the top of the vessel.

**Two-phase vertical coalescer.** The two-phase vertical coalescer (Fig. 13) is typically found in either the top or bottom of liquid-liquid contacting towers such as liquefied petroleum gas (LPG) amine treaters. These coalescers remove the very small amounts of entrainment coming from the interface and return them to the interface to minimize either the loss of valuable solvent or to prevent problems such as corrosion or off-spec product.

Media design for two-phase vertical coalescers is different from the horizontal design due to the flow direction for the coalesced droplets relative to the main process flow. In all the horizontal coalescers and settlers, the coalesced droplets rise or fall at an approximate 90° angle to the main flow. In a vertical coalescer, the coalesced droplets must flow at a 180° angle from the main flow, i.e., they need to flow countercurrent to the main flow direction or essentially “swim upstream.” Under

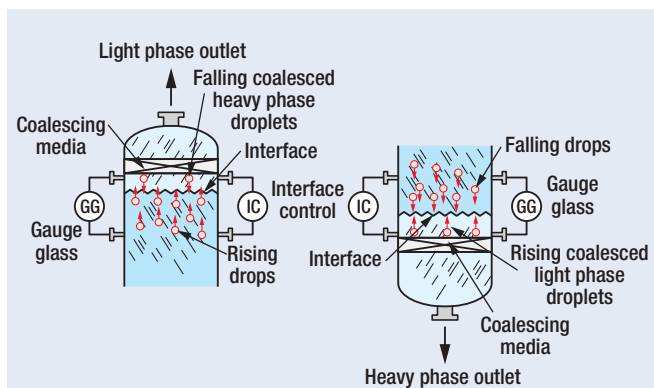

**FIG. 13** Typical arrangement of a two-phase vertical coalescer.

these conditions, the droplets must grow to a larger size before breaking away from the media so that they can rise (or fall) against the drag force imposed by the continuous phase flow.

The droplet sizes to be removed in these applications are very small, with Sauter mean droplet sizes less than 100  $\mu$ . These critical applications require specially designed media. These elements have several zones and utilize a combination of knitted wire and fiber to achieve high efficiency and high capacity. Fig. 13 shows several options, based on the continuous and dispersed phases, for locating these coalescers in the tower relative to the location of the tower primary interface.

**Overview.** Efficient liquid-liquid separations is an integral part of many HPI processes. The complex nature of both the creation and separation of liquid-liquid mixtures makes equipment design nearly impossible from first principles alone. Therefore, when addressing these processing problems, experience with similar applications or laboratory or pilot-plant data is needed. **HP**

---

**Roger Cusack** holds BS and MS degrees in chemical engineering from Manhattan College, New York. After graduation, Mr. Cusack worked for Exxon Research and Engineering Co., in the area of process design for both refineries and petrochemical plants. He subsequently worked for Chem-Pro Corp., the Otto York Co. and Glitsch Technology Corp., where he specialized in the areas of modular plant design and liquid-liquid extraction. Mr. Cusack is co-author of the liquid-liquid extraction chapter of *Perry's Handbook*, Seventh Edition. At Koch-Glitsch, Mr. Cusack specializes in the areas of gas-liquid and liquid-liquid separation technology.