

***FCC Debutanizer Revamp for Flexibility and
Additional Capacity***

by

Daryl W. Hanson, Koch-Glitsch Inc., Houston, Texas

Todd Becker, CITGO Petroleum Corporation, Lake Charles, Louisiana

Mike R. Resetarits, Koch-Glitsch Inc., Wichita, Kansas

Presented at the Distillation Symposium
2001 AIChE Spring National Meeting, Houston, Texas
April 22-26, 2001

UNPUBLISHED

Copyright Daryl W. Hanson, Todd Becker, and Mike R. Resetarits

The AIChE shall not be responsible for statements or opinions contained in its publications.

Daryl W. Hanson

Koch-Glitsch, Inc.

12221 East Sam Houston Pkwy N

Houston, TX 77044

Phone: 713-427-7612

Facsimile: 713-427-7613

Todd Becker

CITGO Petroleum Corporation (formerly with BP Americas – Toledo)

P.O. Box 1562

Lake Charles, LA 70602

Phone: 337-708-0000

Facsimile: 337-708-0000

Mike R. Resetarits

Koch-Glitsch, Inc.

4111 E. 37th Street North

Wichita, KS 67208-0127

Phone: 316-828-8220

Facsimile: 316-828-7985

Introduction

In the past few years, the refining and chemical industry (referred to as operators throughout the paper) have placed an emphasis on maximizing the value creation of each individual unit in the plant. This goal of maximum value creation has placed importance on the operators to maximize capacity of each unit to the major equipment bottleneck. The competitive marketplace has dictated that while operating at maximum capacities for the major equipment, the operators find ways to operate reliably for a four to six year run length or more.

The two goals of maximum capacity and reliability have placed economic emphasis on the revamps that occur during the unit shut-downs. Operating companies that select to revamp units are placing more responsibility and pressure on the equipment vendor to insure that the goals of the revamp are secured during post-revamp operation ¹. Many times, the goals for distillation units include:

- Reliability.
- Capacity.
- Pressure Drop.
- Efficiency.

Since many of the goals above are intertwined, it is important that the operator realize the importance of the vendors experience when involved in the retrofit design.

Operators have determined that it is more economically feasible to fix a problem with a solution that is 100% correct, than to start-up and have a failure with a solution that is only 50% correct.

Operators are finding that it is getting increasingly important to revamp towers with the least risky option. This is especially true for the “fixed equipment” in an operating facility. By fixed equipment, the authors are referring to equipment that can not be revamped or replaced on-line. The fixed equipment commonly causes the rest of the operating facility or other supporting units to be shut-down before a revamp can be initiated. Causing an operating facility or supporting unit shut-down is a large economic impact that all plants should avoid to be competitive.

The authors wish to share a complete case study of a recent FCC Debutanizer revamp. We say complete because the original revamp of the distillation column was undertaken in 1995. In 1995, the tower was revamped from conventional trays to a “High Capacity” mini-valve tray ².

After not meeting the capacity goals that the operator had intended, the tower had to be revamped a second time in early 1999 to achieve the original goals for the revamp. We will describe the complete

troubleshooting exercise, provide operating data & scans for the revamps, and provide the economics that BP-Amoco realized.

BP Amoco – Toledo Refinery

BP-Amoco is a major worldwide operator of both refining and chemical plants. Their main production is concentrated in Petroleum Products, Ethylene, Propylene, Propane, Aviation Fuel, Jet, Kerosene, four grades of Gasoline Grades, Low and High Sulfur Diesel, Decanted Oil and Coke. The Toledo Refinery runs at a capacity of 150 MBPD of crude.

The refinery layout includes two crude units, FCC, Isocracker, reformers, cokers, and alkylation plants. BP-Amoco Toledo supplies products to the mid-west retail and chemical facilities. The FCC unit generates one third of the refinery's gasoline and 100% of the propylene production. Therefore, as in any other refinery, it plays a key role in the economics for the refinery.

FCC Liquids Recovery Unit

With the spotlight in the refinery on the FCC Unit, operators are concerned with maximum FCC feed capacity, olefins recovery, and improved product qualities. In the FCC Unit, considering the main distillation columns, there are major driving forces for revamps. The FCC liquids recovery units place particular requirements on the distillation internals. Some of the distillation towers with their specific operating conditions are listed below:

- Main Fractionator – Typically, tower operates at less than 35 PSIG in the spray regime for tray operation. Limitation is typically vapor flooding.
- De-ethanizer Absorber / Stripper – Typically operates at 210 PSIG in the froth regime for tray operation. Limitation typically due to high liquid rates and downcomer backup issues.
- Depropanizer / Debutanizer – Typically operates at 250 PSIG (De-C₃) and 150 PSIG (De-C₄). Limitation typically due to very high liquid rates and downcomer backup issues. These columns commonly have fouling problems for RFCC or ethylene units.
- C3 Splitter (Propylene Splitter) – Column either operates at low pressure (150 PSIG) or high pressure (225⁺ PSIG). The operation is defined by L/V ratios close to one (1) and reflux ratios of 9-15, depending on the number of theoretical stages, tray efficiency, and propylene recovery. Limitation is typically liquid handling and downcomer backup issues.

Due to the varied operating conditions, concern has to be placed on the choice of distillation internal to achieve the required goals for the revamp. A solution that is tailor made for the FCCU MF^{3,4} may not work for the high pressure light-ends fractionators⁵ due to the different operating regimes and unique internal loadings.

FCC DEBUTANIZER REVAMP FOR FLEXIBILITY AND ADDITIONAL CAPACITY

Proper application of a distillation product is crucial to achieve success. Improper application of distillation internals will promote projects that do not meet operating goals.

BP-Amoco's LRU

The FCC gas plant for the BP-Amoco Toledo refinery is shown in the figure below.

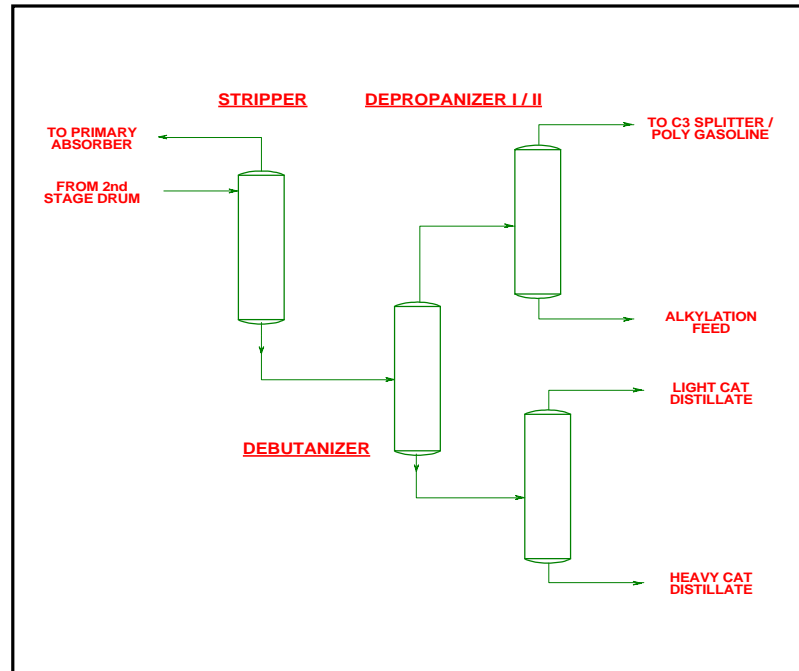

**Figure 1: FCC Liquids Recovery Unit
BP-Amoco Toledo Refinery**

The liquids recovery unit (LRU) is typical of most major FCC units.

The Deethanizer absorber / stripper system is operated in order to maximize C_3 recovery and C_2 rejection. The bottoms of the stripper flows to the Debutanizer where FCC gasoline is stripped to an RVP limit. The overhead of the Debutanizer is sent to the downstream Depropanizer where the C_3 's are separated from the butanes. The overhead of the Depropanizer is sent to the P/P Splitter where propylene is produced for local consumption.

For BP-Amoco, operating goals for the LRU are for maximum C_3 recovery, maximum gasoline recovery to a specified RVP, and for minimum C_5 breakthrough in the Debutanizer overhead. C_5 breakthrough increases acid consumption in the downstream alkylation unit.

FCC DEBUTANIZER REVAMP FOR FLEXIBILITY AND ADDITIONAL CAPACITY

As previously mentioned, the Debutanizer provides the key separation between FCC Gasoline and Butanes in the LRU. Some of the common variables are controlled from the Debutanizer:

Table I: Key Debutanizer Operating Parameters

Feed Temperature (°F)	235
Overhead Pressure (PSIG)	130
Overhead C5 (% mol)	0.5
Debutanized Gasoline RVP (PSIG)	6.5

Debutanizer Revamp #1 - 1995

Prior to the 1995 revamp, the Debutanizer was identified as a bottleneck to achieve the anticipated capacity and product recovery of the FCC in the future. The LRU and treating sections were to be debottlenecked to allow for 93% C₃ recovery. Thus, the debutanizer was seen as a bottleneck at the design FCC feed rate, conversion, and proposed recovery.

The Debutanizer contains 36 trays with the feed location between Tray #15/16 from the top (see Figure #2 for a schematic of the Debutanizer).

Figure #2: FCC Debutanizer PFD

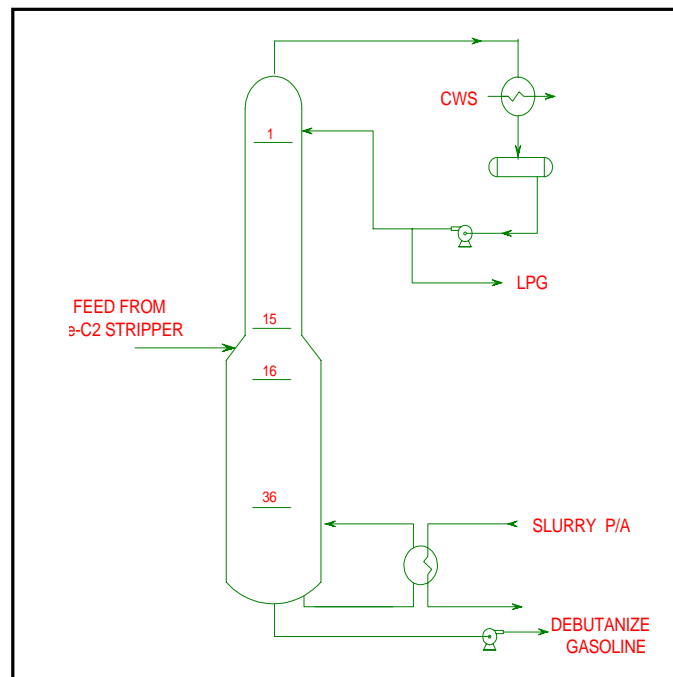

FCC DEBUTANIZER REVAMP FOR FLEXIBILITY AND ADDITIONAL CAPACITY

The Debutanizer overheads is water cooled prior to entering the flooded overhead drum. The reflux is flow controlled to the tower. The overhead product is controlled via flow and pressure control to two Depropanizers. The reboiler heat is supplied via hot slurry oil and is controlled based on an RVP analyzer / tray temperature combination.

BP-Amoco initiated a study of the Debutanizer that confirmed the existing Debutanizer standard valve trays would be the limitation. Prior to the shut-down, BP-Amoco initiated the bid process to select the vendor to replace the distillation internals. BP-Amoco decided that to minimize the field work during the shut-down they would replace the trays with a high capacity mini-valve tray.

During the 1995 shut-down, the trays were replaced and inspection completed to allow unit start-up late in 1995. After start-up, BP-Amoco noticed that the Debutanizer was limiting the throughput of the FCCU. For the Debutanizer, this was not an envious position to occupy. For the next six months, BP-Amoco concentrated on characterizing the tower's performance to locate the bottlenecks to further capacity throughput.

The Debutanizer operation was far from design or acceptable conditions. The design parameters and Revamp #1 operating parameters are below in Table II.

Table II: Operating Parameters: Design vs. Revamp #1

Parameter	Design	Revamp #1 *
Feed (BPD)	53,000	46,500
Tower Pressure (PSIG)	140	138
Tower DP (PSIG)	3.5	3.89
Drum Temperature (°F)	70	66
Top Temperature (°F)	150	148
LPG (BPD)	18,600	12,550
Reflux (BPD)	22,900	17,000
Overhead C ₅ (% mol)	0.5	3.22
DeC4 Gasoline (BPD)	34,600	33,950
Gasoline RVP (PSIG)	6.4	6.6
Gasoline D-86, °F		
IBP	106	108
10%	136	122
30%	168	156

* Operation prior to flood point (from 24 March 98). Tower flooded at reflux of 17,500 BPD.

The summary for the Revamp #1 considers the maximum internal loadings that the trays could handle prior to the flood point. Operations and engineering could flood the trays by watching the pressure drop through the tower. When the pressure drop reached 3.7-3.9 PSI, the tower would exhibit liquid back-up and proceed into a tail-spin flood.

The capacity deficit of the Revamp #1 was a large problem for the Debutanizer. Associated problems were the product purities for the Debutanizer. As a consequence of not meeting internal loadings, operations for the FCC were impacted:

- Debutanized gasoline RVP was high and thus blending flexibility was lost for the refinery. Capacity in the stripping section limited the RVP to a low of 6.6 PSI.
- C₅ content in the overhead was high due to the limitation in the rectification section. The reflux was limited to 17,000 BPD at high feed rates before tray flood. At this reflux, 3% mole C₅'s were left in the overhead. Sending C₅'s to the alkylation unit consumed acid, which was a large debit for the operations.

Troubleshooting Revamp #1:

Upon identification of the Debutanizer limitation, troubleshooters from B.P.-Amoco immediately began identifying possible reasons for the under-performance of the tower. Some are listed below, and ruled out later:

- Flow meter errors.
- Damage to the trays.
- Mis-installation of the trays.
- Plugging of the internals with polymer material.

As part of the troubleshooting, BP-Amoco utilized isotope scanning of the tower in order to rule out some of the above possibilities. Scanning has been used extensively in order to "look inside" the column to find the source or operating condition of the flood.

Contrary to some beliefs ⁶, the authors believe that the results from "advanced" scans can provide excellent information to be used in the troubleshooting adventure. For example, in a high pressure gas plant, how would a person diagnosis a high liquid level in the bottoms boot section? Level bridges in this service are known to be skewed by foaming. The temperature drops are small, the pressures are high so the liquid head measurements lack precise meaning, so scanning provides a basic and seemingly easy look inside the operating column if executed correctly.

When a problem is evident, the troubleshooter should not forgo any source of general information. It is up to the troubleshooter to find out which pieces of information are of primary importance, and which to consider as secondary importance.

FCC DEBUTANIZER REVAMP FOR FLEXIBILITY AND ADDITIONAL CAPACITY

Within the organization, the reasons listed above for flooding were routinely ruled out after additional scan and process data were becoming available. Shown in the figures attached are the scans that BP-Amoco executed for the stripping section and rectification section.

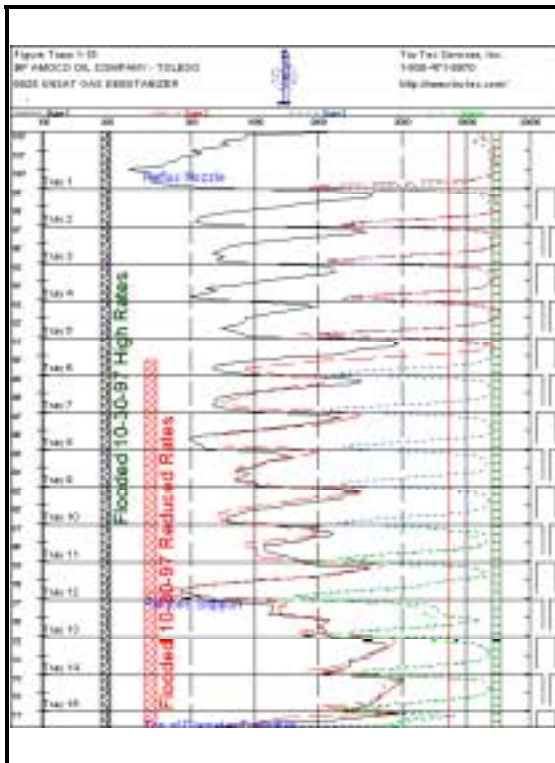

Figure #3: Rectification Section Scan of Revamp #1 @ conditions listed in Table II

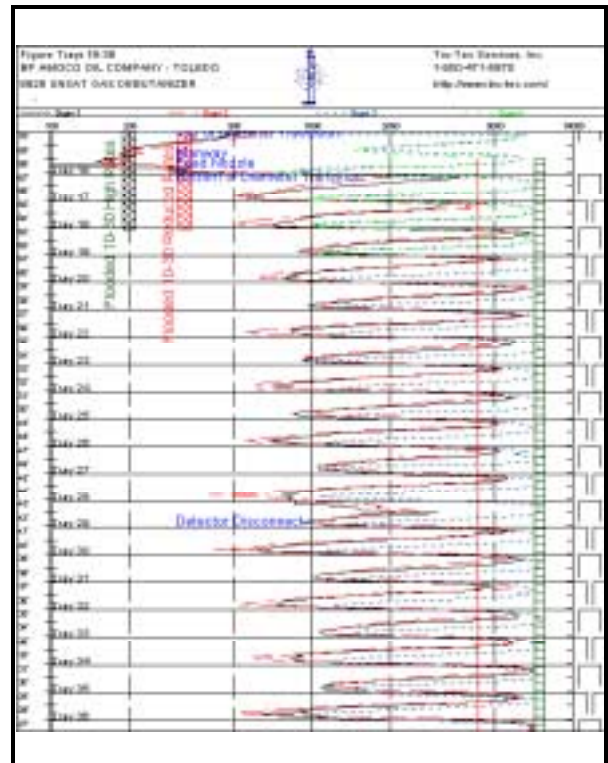

Figure #4: Stripping Section Scan of Revamp #1 @ conditions listed in Table II

The tower was scanned through the active areas of the tray. The scan identifies the flooded areas of the tower. When a tray is at or above incipient flood, the scan line for the active area starts to move away from the hatched area called “clear vapor space”. This indicates froth entrainment to the tray above and signifies that liquid is not obtaining disengagement from the up-flowing vapor.

The scan identifies that both the rectification and stripping section of the tower are operating at flooded conditions (liquid height on the tray decks is high), at lower than design rates. The Revamp #1 trays were operating at a small increment higher rates than the former sieve trays.

Tray Capacity – High Weir Loadings

This tower, like many other high pressure columns, operated at considerable weir loadings. The weir loadings for this revamp approached 16 GPM/inch (192 GPM/ft) of weir in the stripping section of the tower. This is considered extreme liquid loadings by many distillation practitioners in the industry.

The authors fear that the weir loading criteria is overstated as the primary indicator of liquid capacity of a distillation internal. The authors have several applications of towers that have been designed with liquid weir loadings over 20 GPM/inch.

Several different possibilities for weir loading operation exist. Schematic of the Low Weir Loading vs. High Weir Loading is shown in the following figure.

Figure x: Low vs. High Weir Loading

Low Weir Loading Operation

High Weir Loading Operation

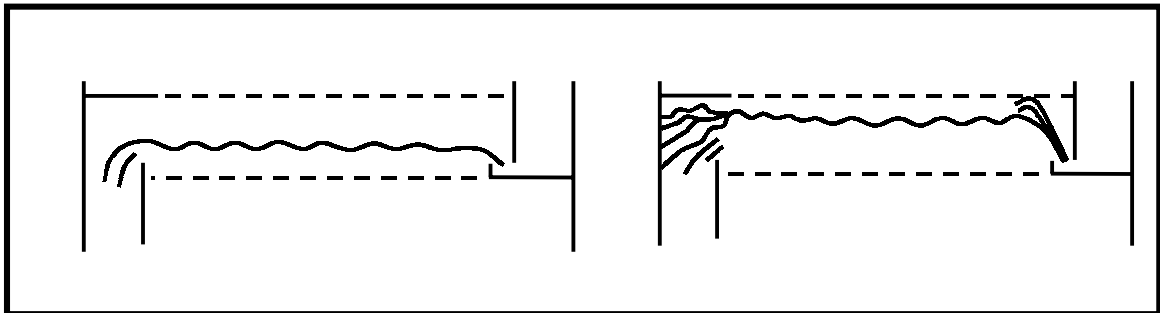

At high weir loadings, several phenomena occur:

- Inlet “Liquid Rooster Tail” appears as described by Lockett.
- The disengagement space becomes shorter due to increased froth height on the tray.
- Liquid “jump” over outlet weir becomes high and downcomer inlet velocity is affected.
- Liquid has difficulty in entering into downcomer mouth.

All of these factors, if not considered in the tray design methodology, may cause performance shortfalls.

There are many liquid loading criteria that have can be extracted from public domain materials. One of the more prominent liquid loading criteria can be found in the Lockett ⁷.

Figure 5: Maximum Weir Loading vs. Tray Spacing (Lockett, 1986)

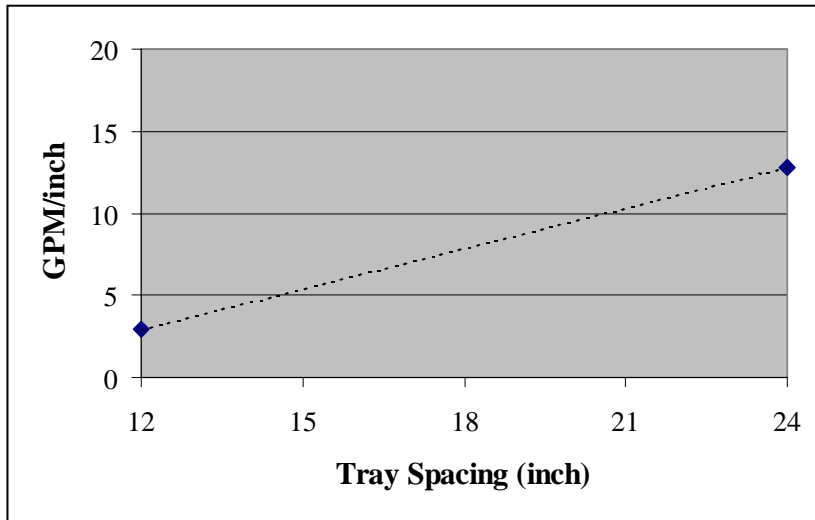

The above criteria are industry accepted guidelines. Koch-Glitsch has exceeded these high liquid guidelines by utilizing specialized tray features to limit froth height and promote liquid distribution to the active area. These applications have been made possible by testing Superfrac trays in the pilot plants at loadings up to 25 GPM/inch of weir.

Analysis of Revamp #1 Shortfall

BP-Amoco was concerned about the capacity of the Revamp #1 installed trays. There were still a few concerns that had to be rectified prior to finalizing the path forward for the tower:

1. Is the under-performance caused by tray damage ?
2. Is the under-performance caused by plugging on the tray decks ?

The first question above was addressed during the scan shown in Figure #3. If the tower had seen tray damage, this would be evident in the scan. A damaged tray can show several characteristics in a scan through the active area. Most of the time with a damaged tray, the scan at the tray elevation will show up with a sharp peak that falls as quickly as it ascends. This indicates no “froth” or liquid build-up / activity on the tray. All of the trays in the scan show liquid build-up, so therefore, damage was excluded from the list of possible causes.

FCC DEBUTANIZER REVAMP FOR FLEXIBILITY AND ADDITIONAL CAPACITY

The second question was an interesting question that could not be directly assessed from outside the column. Many FCC and Ethylene plant Debutanizers exhibit fouling due to polymerization. Typically, the fouling originates around the feed point, on the bottom few trays, and in the reboiler due to the high temperature at the bottom of the column. We believe that this polymer formation can be attributed to vapor phase combination of olefins including butadienes and pentadienes.

In the FCCU, Debutanizer fouling has been traced to the severity of cracking and the ° API of the oil being cracked. During previous shut-downs the Debutanizer was clean and showed no signs of fouling. But BP-Amoco was concerned that this may cause the current under-performance problems, so they investigated this possibility.

Debutanizer Revamp #2 - 1998

Since the Debutanizer was limiting any further FCC capacity increases, BP-Amoco decided to revamp the Debutanizer for a second time in 1999. They still did not have a clear indication if the trays were fouled or if they were just under-performing.

In 1999, BP-Amoco decided to revamp using SUPERFRAC® trays to debottleneck the FCC Debutanizer. The key to this decision was deciding on the likelihood of fouling. Due to the prior inspection reports that indicated no fouling, BP-Amoco was confident fouling was not occurring.

Revamp Alternatives - Tray Comparison

For the Revamp #2 scenario, BP-Amoco considered two options for the revamp. Scenario #1 included increasing the number of passes for the trays to handle the high weir loading. Scenario #2 included revamping the tower with Superfrac trays, retaining the two pass layout of the existing tower attachments.

Scenario #1 was considered due to BP-Amoco's failure with the existing two pass trays. The four pass trays would offer more weir length for liquid flow, which would increase the liquid handling capacity of the trays. By far, the two pass tray revamp (Scenario #2) would offer the best economic solution for BP-Amoco solely due to the installation time requirements for modifying the existing tower attachments to go to a four pass option.

Koch-Glitsch offered BP-Amoco a revamp with two pass Superfrac trays. As part of the verification, Koch-Glitsch supplied B.P.-Amoco with reference columns operating at very high weir loadings. The design weir loadings for the revamp were 12.5 and 15.2 GPM/inch of weir for the center and side downcomers, respectively. Only 5-10% of high pressure columns operate at these high liquid loadings.

BP accepted the recommendation and contacted the available reference for input to the particular design considerations. The critical design parameter was to settle on the tray dynamics and design while operating at high liquid rates. The liquid rates for this design required several particular design modifications to the tray to handle the high liquid and the resultant liquid gradients on the tray.

Figure 6: Superfrac Multi-Step Downcomer for High Liquid Rates

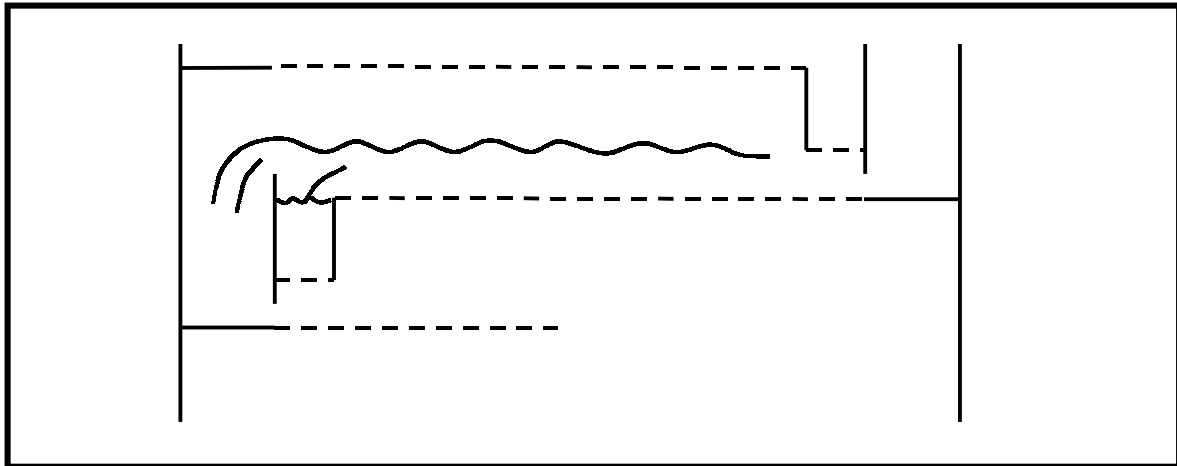

Utilizing the Multi-Step Downcomer (MSD) eliminates a portion of the crest height of liquid over the weir so the resultant froth height on the tray is lower. This provides additional capacity for the tray by increasing the amount of disengagement space at a particular design capacity. Because the MSD is immediately prior to the downcomer (at the exit), the efficiency of the tray is not hampered by any reduction in liquid residence time on the tray.

For this debutanizer, this revamp required that the new trays fit up to existing downcomer bolting bars. No adaptors (Z-bars) were utilized to increase the downcomer sizing. Koch-Glitsch did not recommend changing or enlarging the size of the existing downcomers. To make fit-up in the field easier, Koch-Glitsch filled in the existing inlet sump. The inlet sump was utilized by the prior trays to decrease the downcomer aerated backup by providing more room for de-aeration in the downcomer. This feature was not utilized for the revamp design.

FCC DEBUTANIZER REVAMP FOR FLEXIBILITY AND ADDITIONAL CAPACITY

This case study provides an excellent reference on increasing a tower's capacity, without adding additional downcomers that debit the tray's efficiency. The interesting thing about this revamp is that the Superfrac trays have gained capacity increase without adding additional downcomers or downcomer area to the tray.

To alleviate some of the concern regarding fouling, Koch-Glitsch designed some of the trays with anti-fouling technology. The top and bottom trays in the stripping section were fitted with this technology to promote "plug flow" across the tray. This would insure that any fouling material was cleaned from the tray and would not stagnate on the tray deck.

BP-Amoco justified the change on increased C₃ recovery, improved RVP control, improved Alkylation feed quality. This would increase the loadings on the Debutanizer by 6% over the Revamp #1 loadings. As part of the debottlenecking study, they also decided to add a pre-heater to the feed in order to vaporize some of the feed to relieve the reboiler and stripping section loadings and to add operating flexibility.

Table III: Operating Parameters: Revamp #1 vs. Revamp #2

Parameter	Revamp #1*	Revamp #2**
Feed (BPD)	46,500	49,025
Tower Pressure (PSIG)	138	130
Tower DP (PSIG)	3.89	3.94
Drum Temperature (°F)	66	94
Top Temperature (°F)	148	139
LPG (BPD)	12,550	15,997
Reflux (BPD)	17,000	31,055
Overhead C ₅ (% mol)	3.22	< 0.1
DeC4 Gasoline (BPD)	33,950	33,028
Gasoline RVP (PSIG)	6.6	6.1
Gasoline D-86, °F		
IBP	108	117
10%	122	119
30%	156	159

* Operation prior to flood point (from 24 March 99). Tower flooded at reflux of 17,500 BPD.

** Maximum operation to date. Limited by reflux pump.

As part of the revamp, Koch-Glitsch assisted BP-Amoco in the process development for the revamp. Koch-Glitsch also assisted BP-Amoco in the post-revamp audit for the unit to insure the tower reached its required capacity. To date, the tower has not been flooded. We have pushed the tower to the maximum reflux pump capacity, while the tower showed no signs of being close to the flood point. Revamp #2 testing was executed with the feed vaporizer almost fully by-passed and was

limited by the reflux pump. BP-Amoco pushed the unit to the limit while recovering every barrel of LPG available in the feed.

Economic Analysis

When looking at this comparison, the authors wish to point out that this project began to correct a capacity deficit. In other words, a revamp to handle the anticipated FCC gasoline production was required to achieve the required pay-out for the refinery.

After operating for approximately nine months now, B.P.-Amoco has achieved several un-foreseen advantages for the revamp that has had a significant impact on unit & refinery economics:

1. Lowering Debutanized Gasoline RVP.
2. Lower than design C₅ content in the alkylate feed stream.

Both of these benefits were unexpected for B.P.-Amoco, but had tremendous pay-out.

Shown below is the refinery gasoline pool for the Toledo refinery. The blending streams entering into the gasoline pool come from the FCC, Alkylation, Isomerization, Coker, and Crude units.

Figure #5: Refinery Gasoline Block Diagram

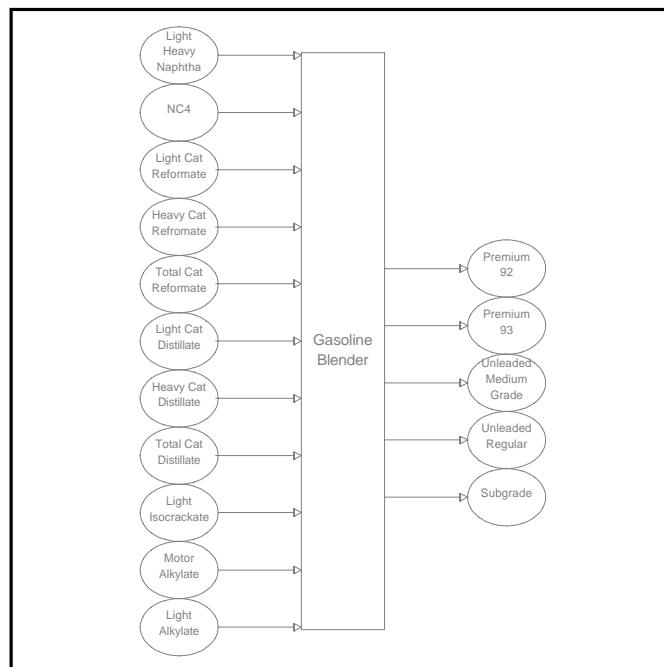

The “finished gasoline” to sales has to meet certain distillation properties for the local market, seasonal vapor pressure regulations, and sulfur limitations.

FCC DEBUTANIZER REVAMP FOR FLEXIBILITY AND ADDITIONAL CAPACITY

Lowering the FCC Debutanized gasoline RVP, the largest product stream to the pool, provided BP-Amoco with additional flexibility in other units. Since the FCC gasoline was the largest volume contributor to the pool, a deviation was controlled by modifying the smaller streams. After revamp #1, the tower could barely meet the 7.5 PSI RVP limitation to meet the lower RVP summer operations. At the high RVP, all other pool streams had to be processed at a lower light-ends composition. This was particularly limiting to the blending flexibility at the refinery. This took a particular toll on some of the other processing units that were already at their limitations.

The second surprise pay-out also dealt with operations flexibility. For the Revamp #1, operations was limited at the maximum feed rate to a reflux of 17-18,000 BPD. At this reflux rate, the trays were on the verge of flooding and the C₅ content in the overhead was 4-5%. The overhead depropanized butanes are sent directly to the Alkylation plant for conversion into gasoline.

The Alkylation plant processes the C₄'s from the Debutanizer. Incremental amounts of C₅ in the overhead consume acid in the Alkylation plant thus increasing the operating cost for the Alkylation plant. For the Revamp #2, the Toledo refinery realized a savings of \$1.6 MM USD per year just based on lower acid consumption.

References

1. Hanson, D.W., Einwich, J.M., and Pratt, W., "Revamping High Pressure Fractionators for Capacity and Efficiency", Presented at AIChE Spring Meeting, Houston, March 1999.
2. Nutter, D.E. and Perry, D., "Sieve Upgrade 2.0 – The MVG Tray", Presented at AIChE Spring Meeting, Houston, March 1995.
3. Hartman, E.L., Hanson, D.W., and Weber, B., "FCC Main Fractionator Revamp for CARB-II Gasoline Production", *Hydrocarbon Processing*, February 1998, pp. 44-49.
4. Golden, S.W., Martin, G.R. and Schmidt, K.D., "Field data, new design correct faulty FCC tower revamp", *Oil & Gas Journal*, May 31, 1993, pp. 54-60.
5. Hanson, D.W. and Hartman, E.L., "Ethylene & FCCU gas plant revamps for higher capacity and efficiency", Presented at the Stone & Webster 11th Annual Refining Seminar, Dallas, October 5, 1999.
6. Nigg, J.M. and Sitton, K.D., "Improve the reliability and maintenance of FCCU Main fractionator internals", *World Refining*, May-June 1999, pp. 87-91.
7. Lockett, M.J., *Distillation Tray Fundamentals*, Cambridge University Press, New York, 1986.
8. Kister, H.Z., *Distillation Operation*, McGraw-Hill, Inc., New York, 1990.